



Tél. 04 78 74 04 15 - Fax 04 78 01 61 80 - office@nichrominox.fr - www.nichrominox.fr

NICHROMINOX

NICHROMINOX - 18, rue des Frères Lumière - F 69720 SAINT-BONNET-DE-MURE- FRANCE

CATALOGUE 2015/2016

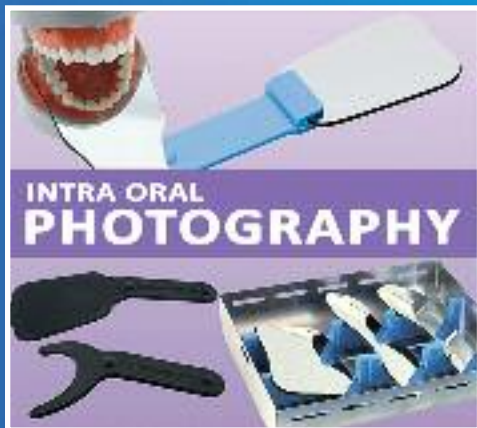
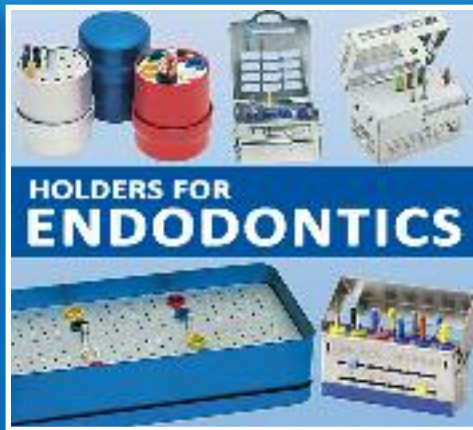

Made In France



High Performance Bur Stands

The Plug'In - A new Concept for Bur Holders

THE SILICONE PLUGS HOLD ANY TYPE OF BUR SECURELY

Stainless steel and silicone. Can be used with all known decontamination, cleaning and sterilization processes. Can be rotated to offer the burs flat or at an angle. Will hold FG or CA burs whatever their diameter. Keep the instruments safe and save assistant time. Available in **2 3 4 5** colours.



Plug'In 4 holes - Size 4,5 x 2 x 3 cmRef. 190205

Plug'In 10 holes - Size 5,2 x 2,5 x 3 cmRef. 190213



Plug'In 6 holes - Size 3,5 x 2,5 x 3 cmRef. 190208



Plug'In 12 holes - Size 6,3 x 2,5 x 3 cmRef. 190211



Plug'In 8 holes - Size 4,5 x 2,5 x 3 cmRef. 190210



Plug'In 16 holes - Size 8,5 x 2,5 x 3 cmRef. 190212

High Performance Bur Stands



The two rows are inclined to give a clearer view and better access

Ergo Plug

8 holes - Size 5 x 3,3 x 2,8 cmRef. 190310
 16 holes - Size 8,5 x 3,3 x 2,8 cmRef. 190312

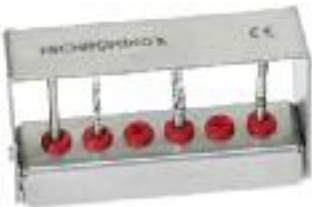

Plug'In 6 holes H. 4 cm
 Size L. 7,5 x l. 2 cm
 • Ref. 206002



Plug'In 12 holes H. 4 cm
 2 rows of 6 holes
 Size L. 7,5 x l. 2,5 cm
 • Ref. 206012



Plug'In 6 holes H. 5 cm
 Size L. 7,5 x l. 2 cm
 • Ref. 206000



Plug'In 12 holes H. 5 cm
 2 rows of 6 holes
 Size L. 7,5 x l. 2,5 cm
 • Ref. 206010



Plug'In 6 Holes H. 6 cm
 Size L. 7,5 x l. 2 cm
 • Ref. 206003



Plug'In 6 Holes H. 7 cm
 Size L. 7,5 x l. 2 cm
 • Ref. 206004



new

Plug'In 20 holes

Size 9,7 x 3,5 x 3,4 cmRef. 190214
 Small in size, large in storage



Plug'In 30 holes

Size 11 x 3,5 x 3,4 cmRef. 190230
 Small in size, large in storage



new

Maximum storage of burs

Plug'In 40 holes

Size 10,9 x 8 x 3,5 cmRef. 190218

Maximum storage of burs



Plug'In Plate with 40 holes And Cassette

- Plug'In Plate - Size 11 x 8 x 1,5 cmRef. 190215
- Cassette + Plug'In Plate - Size 11,5 x 9 x 4 cmRef. 190217
- Cassette (empty) - Size 11,5 x 9 x 4 cmRef. 190216

High Performance Bur Stands



MULTI PLUGS

Stainless steel and silicone

Size 6,3x2,5x5,1 cm. Will support any type of decontamination, cleaning and sterilization process. **Notches cut into the sides make it easy to remove the tips from the hand piece.**

- Multi Plug 2+2 - 2 scaler tips + burs or brushesRef. 190421
- Multi Plug 5 - 5 scaler tipsRef. 190420



MULTI PLUG'IN

For 6 burs of any diameter

and 2 scaling inserts or other similar accessory

Size 6 x 2,5 x 4,2 cmRef. 190410



MULTI HOLDER CLIP

- 2 holes - Size 3,5 x 2,5 x 4,1 cmRef. 205025
- 6 holes - Size 6 x 3,5 x 4,8 cmRef. 205022

Stainless steel and silicone.

Ideal for storage and sterilization of scaling inserts and other accessories Ø 3,5 à 5 mm



MULTI HOLDERS

Stainless steel and silicone. Size 6 x 4,5 cm

Ideal for surgical burs, implantology drills, scaling inserts, and other accessories. For storage of 6 instruments.

- 6 holes Ø 2 à 3,5 mmRef. 205010
- 6 holes Ø 3,5 à 5 mmRef. 205012

Bur Clip Colour 8 et 17 holes

Stainless steel - Self locking cover. Complete with 4 interchangeable colour indicator strips



Bur Clip with FG holes are fitted with a blue indicator and Bur Clip with Mx holes with a green indicator. Ideal for use in ultrasonic baths, cleaners, disinfectors (can be placed in autoclave pouches).

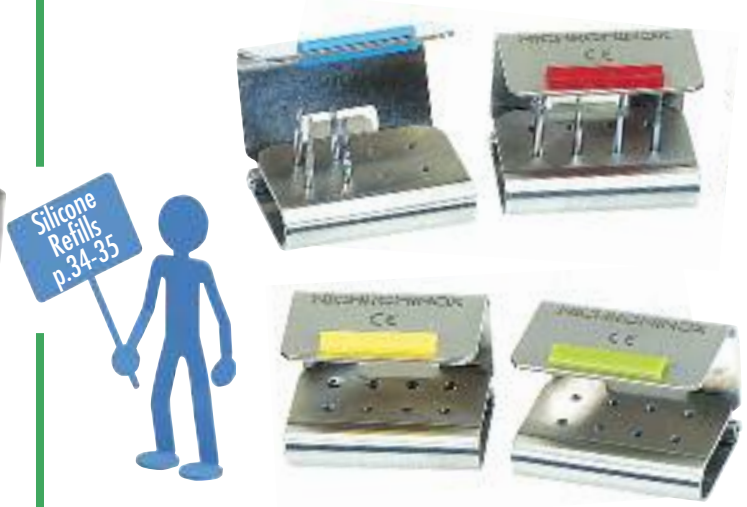

BUR CLIP COLOURS 8 HOLES

Size 3,5 x 2,8 x 2,8 cm

- Bur Clip 8 holes FGRef. 191266
- Bur Clip 8 holes MX (4 FG / 4 CA)Ref. 191265



BUR CLIP COLOURS 17 HOLES

Size 6 x 4,5 x 2,8 cm

- Bur Clip 17 holes FGRef. 191261
- Bur Clip 17 holes MX (12 FG / 5 CA)Ref. 191260

High Performance Bur Stands

Aluminium products : refer to instructions for use

Smart Blocs

Anodised aluminium - Can be used in an autoclave to 134°, chemiclave or dry heat sterilizer. Do not place into an ultrasonic bath or thermal disinfecter. Please ensure any solution used is checked for compatibility with aluminium. Hinged cover completely removable for thorough cleaning.



SMART BLOC 8 HOLES

Size 3 x 3,2 x 2,9 cm

- Smart Bloc 8 holes FGRef.190336
- Smart Bloc 8 holes MX (6 FG /2 CA)Ref.190335

SMART BLOC 14 HOLES

Size 5 x 3,2 x 2,9 cm

- Smart Bloc 14 holes FGRef.190346
- Smart Bloc 14 holes MX (10 FG /4 CA)Réf.190345

Eco Blocs

Anodised aluminium - Can be used in an autoclave to 134°, chemiclave or dry heat sterilizer. Do not place into an ultrasonic bath or thermal disinfecter. Please ensure any solution used is checked for compatibility with aluminium. Cover colour **1** **2**



ECO BLOC 8 HOLES

Size 3 x 2,5 x 3 cm

- Eco Bloc 8 holes FGRef.190236
- Eco Bloc 8 holes MX (4 FG /4 CA).....Ref.190235

ECO BLOC 14 HOLES

Size 5 x 2,5 x 3 cm

- Eco Bloc 14 holes FGRef.190246
- Eco Bloc 14 holes MX (7 FG /7CA)Ref.190245

Maxi Bur Blocks



MAXI BUR BLOCK - 200 HOLES

Size 18,5 x 9,5 x 4,5 cm
160 holes FG + 40 holes CA
• Ref.190260

MAXI BUR BLOCK - 100 HOLES

Size 12 x 8,5 x 4,5 cm
80 holes FG + 20 holes CA
• Ref.190270

MAXI BUR BLOCK - 50 HOLES

Size 10,6 x 4,7 x 4 cm
40 holes FG + 10 holes CA
• Ref.190240

Anodised aluminium - Removable cover. Do not place into ultrasonic bath. Please ensure any solution used is checked for compatibility with aluminium.

High Performance Bur Stands

Bur Flash : Simple and Practical

Stainless steel and teflon. An open and light holder making it easy to see, clean, and sterilize all of your burs. Bur Flash can be stored vertically or horizontally. It will support any type of decontamination and sterilization process.

SO SIMPLE SO SUCCESSFUL

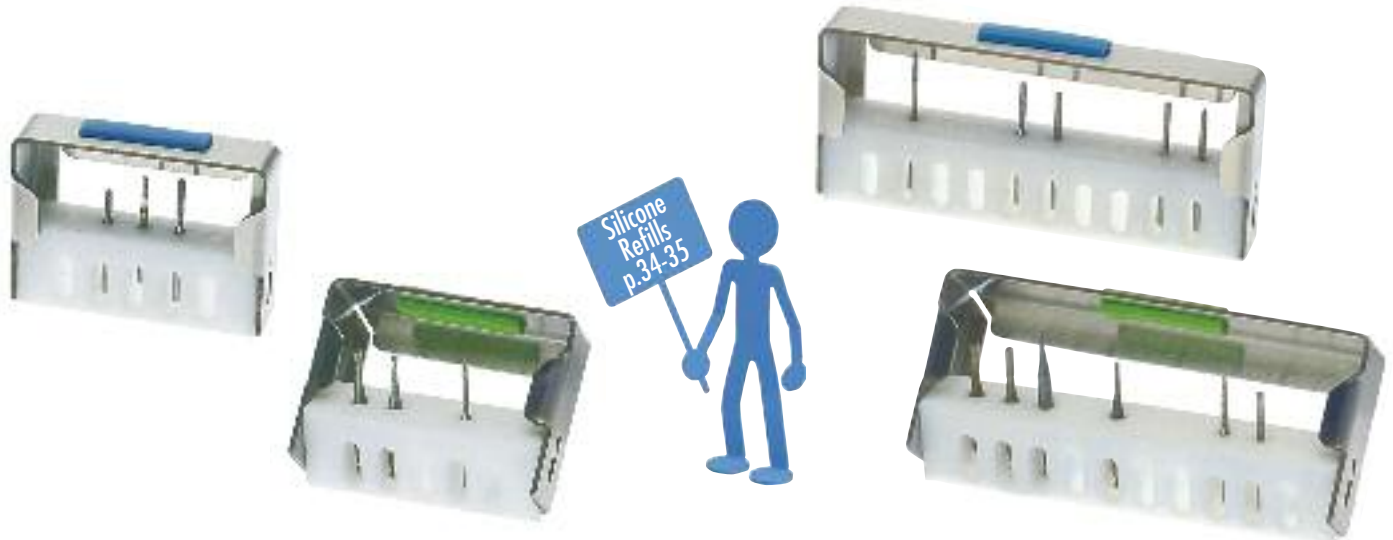

BUR FLASH 5 HOLES Size 4,3 x 3,3 x 1,3 cm

- Bur Flash 5 holes FGRef. 190226
- Bur Flash 5 holes MX (3FG + 2CA).....Ref. 190225

BUR FLASH 10 HOLES Size 7,3 x 3,3 x 1,3 cm

- Bur Flash 10 holes FGRef. 190221
- Bur Flash 10 holes MX (5FG + 5CA)Ref. 190220

Bur Dispensers : Excellent Value

Stainless steel and Teflon - Size 4,5 x 3 x 1,5 cm - 5 holes - Can be rotated in any direction. White Bur Dispensers are available for 5 burs FG-CA or MX (3 FG + 2 CA). Blue **2**, green **4** and yellow **5** Bur Dispensers are available for 5 burs FG only. They will support any type of decontamination and sterilization process.

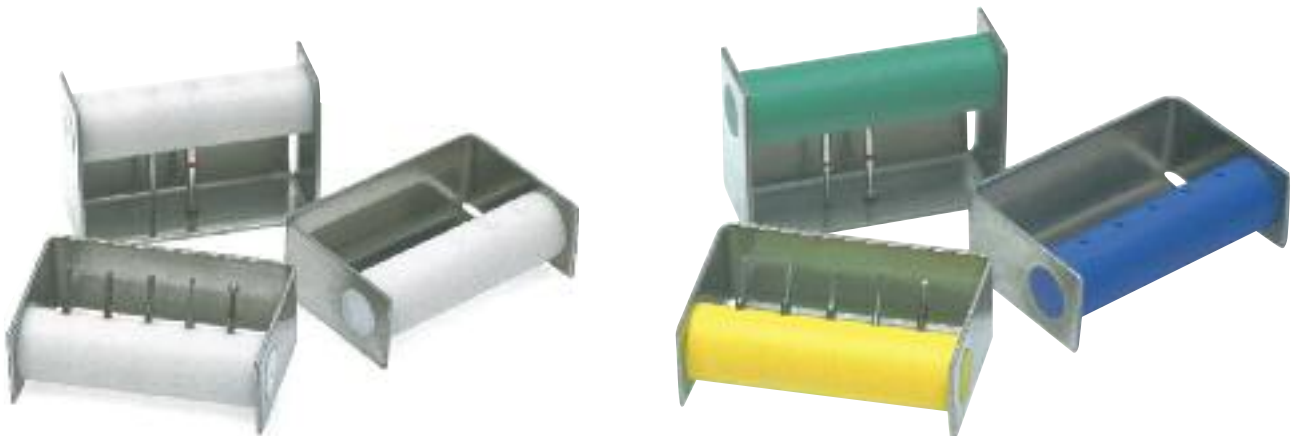

WHITE BUR DISPENSER 5 HOLES

- Bur dispenser - 5 holes FG whiteRef. 190290-8
- Bur dispenser - 5 holes CA whiteRef. 190292-8
- Bur dispenser - 5 holes MX white.....Ref. 190293-8

COLOURED BUR DISPENSER 5 HOLES

- Bur dispenser - 5 holes FG Blue **2**Ref. 190290-2
- Bur dispenser - 5 holes FG Green **4**Ref. 190290-4
- Bur dispenser - 5 holes FG Yellow **5**Ref. 190290-5

High Performance Bur Stands

UltraLight Bur Holders



new

**New Concept,
New Design !**



new

ULTRALIGHT BUR HOLDER 5 HOLES

Size 5,7 x 5,3 x 1,9 cmRef.190370

ULTRALIGHT BUR HOLDER 9 HOLES

Size 9,3 x 5,3 x 1,9 cmRef.190380

Made of Stainless Steel and silicone, they have been designed for use with all disinfection and cleaning solutions, as well as all sterilization processes. (autoclave, etc...). Very strong but light, these Ultralight Bur Holders have been created specifically for use in washer disinfectors, and in ultrasonic baths.

When closed, the Ultralight Bur Holder becomes a cassette, giving a high level of protection for your burs.

The internal holder can be rotated : when opening the cassette, you turn the internal holder vertically to present the instruments making it very easy to use.

Electro polished to give a bright shiny surface finish.

Available for 5 and 9 burs. They will hold any combination of FG or CA burs whatever their diameter.



Bur Blocks



BUR BLOCK

Size 4 x 3 x 2,3 cm
Stainless steel - 12 holes

- Bur block FGRef.190250
- Bur block CARef.190252
- Bur block MX (6FG + 6CA)Ref.190253

MINI BOX + BUR BLOCK

Size 5 x 4 x 2,5 cm
3 holes : FG - CA or MX
• Bur block + aluminium boxRef.190251
The aluminium box comes in 5 colours

1 2 3 4 5

- Bur block + stainless steel box....Ref.192251

BOX + BUR BLOCKS

Size 13 x 5 x 3,5 cm
4 bur blocks (3 FG + 1 CA) in aluminium box (colours **1 2**) or in stainless steel box

- 4 bur blocks alu boxRef.190254
- 4 bur blocks + S. steel box Ref.192254

Endodontic stands "New Generation"



ENDO CASSETTE 1 - 16 Holes

Size 3,5x3,9x5 cm • Ref.182151

ENDO CASSETTE 2 - 32 Holes

Size 6,5x4,3x5 cm • Ref.182150

ERGONOMIC AND EASY TO USE

A stainless steel perforated box with teflon insert, 1 endometer, self locking cover system. Ideal for use in ultrasonic baths, cleaners, disinfectors and includes a silicone cursor on the cover for counting the number of times used.



ENDO PRO - 8 holes

Size 7,7x 5,8x 2 cm • Ref.182350



ENDO PRO - 12 Holes

Size 9,2x 5,8x 2 cm • Ref.182360

HOLES IN THE COVER FOR A MORE EFFICIENT CLEANING PROCESS

Stainless steel and Teflon, 1 endometer, self locking cover system. Ideal for use in ultrasonic baths, cleaners, disinfectors and includes a silicone cursor on the cover for counting the number of times used.



new

ULTRALIGHT ENDO TOP - 16 holes

Size 3,5x3,2x5,2 cm - Ref.182121

ULTRALIGHT ENDO TOP - 32 holes

Size 7x3,2x5,2 cm - Ref.182120

Stainless steel and Teflon. No screws, No hinges, easy to take apart and reassemble. Special for use in washer disinfectors and ultrasonic baths. Will support all disinfection and cleaning solutions as well as all sterilization processes. Fit in all ISO standard cassettes. For a large quantity of instruments : 16 and 32 holes. Silicone cursor on the cover for counting the number of times used.

Endodontic stands "New Generation"



ENDO FLASH 4
Size 4,2 x 1,3 x 5 cm
Ref. 182104



ENDO FLASH 8
Size 7,3 x 1,3 x 5 cm
Ref. 182108



ENDO FLASH 12
Size 9 x 1,3 x 5 cm
Ref. 182112

ENDO FLASH So Simple So Successful

Stainless steel and teflon. An open and light holder making it easy to see, clean, and sterilize. A stable holder when open that can be stored vertically or horizontally. The top locks into position to hold the instruments safely during processing. Silicone cursor for counting the number of times used. Will support any type of decontamination and sterilization.



ENDO STAR 5
For 5 endo instruments and 2 burs
Size 5 x 2 x 5 cm.....Ref. 182160



ENDO STAR 8
For 8 endo instruments and 3 burs
Size 7,3 x 2,5 x 5 cm.....Ref. 182170

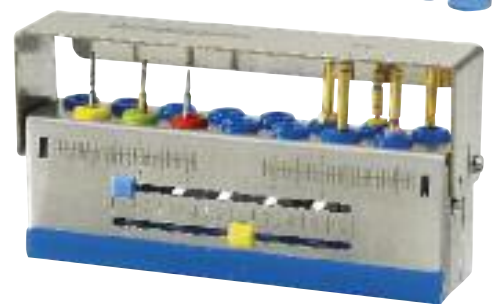

ENDO STAR 12
For 12 endo instruments and 3 burs
Size 9,4 x 2,5 x 5 cm.....Ref. 182180

ENDO STAR The New Concept "All in One"

Stainless steel and silicone. The Endo Star holds your standard or new Nickel Titanium instrumentation, as well as FG or CA burs. 1 ruler to measure your instruments length, silicone cursors for counting the number of times used. Coloured silicone plugs for easier colour coding, 1 non-slip silicone pad (that can be removed during cleaning), 1 self locking cover. Will support any type of decontamination and sterilization.



Ultralight Endodontic Holder
4 Holes Size 5 x 6 x 2 cm Ref. 182320



Ultralight Endodontic Holder
8 Holes Size 8,4 x 6 x 2 cm Ref. 182380



Ultralight Endodontic Holder
12 Holes Size 11,9 x 6 x 2 cm Ref. 182390

New Concept, New Design !

Stainless steel and silicone. Bright shiny surface finish. Special for use in washer disinfectors and ultrasonic baths. Will support all disinfection and cleaning solutions as well as all sterilization processes. When closed the Ultralight Endo holder becomes a cassette giving a high level of protection for endodontic instruments. When opening the cassette you lift the internal holder to present the instruments and make it easy to use. Silicone plugs hold instruments securely. Silicone cursor on the cover for counting the number of times used.

Endodontic stands "New Generation"

Aluminium products : refer to instructions for use



Size 6,5x5x5 cm - Colours 1 2 3 4 Anodised aluminium
Please ensure any solution used is checked for compatibility with aluminium.

ENDO MICRO PULPA

• Ref. 180180 - 30 holes for endodontic instruments.

ENDO MICRO PLUS

• Ref. 180183 - 24 holes for endodontic instruments, 2 autoclavable plastic cups + 1 mini clean gripp.

PULPA / GUTTA BOX

Colours 1 2 3 4 - Anodised aluminium

Size Ø4,8 cm - H.5,5 cm - Please ensure any solution used is checked for compatibility with aluminium.

- Pulpa Box : 18 holes for endodontic instr.Ref. 180150
- Gutta Box : 6 autoclavable plastic cupsRef. 180160



MINI ENDO

• Ref. 180193

Colours 1 2 3 4

60 holes for endodontic instruments, 4 autoclavable plastic cups

MINI ENDO Clean Gripp

• Ref. 180192

Colours 1 2 3 4

36 holes for endodontic instruments, 3 autoclavable plastic cups, 1 clean gripp

ENDO TOTAL

• Ref. 180196 - Colours 1 2
30 holes for endodontic instrum., 6 autoclavable plastic cups, 5 holes for burs (3 FG + 2 CA), 1 endometer, 1 clean gripp, 1 area for cotton pellets

BASIC ENDO TOTAL

• Ref. 180197

Colour 1 only

96 holes for endodontic instruments

Size 12x9x6 cm - Anodised aluminium
Please ensure any solution used is checked for compatibility with aluminium.

Size 12x9x6 cm - Anodised aluminium
Please ensure any solution used is checked for compatibility with aluminium.

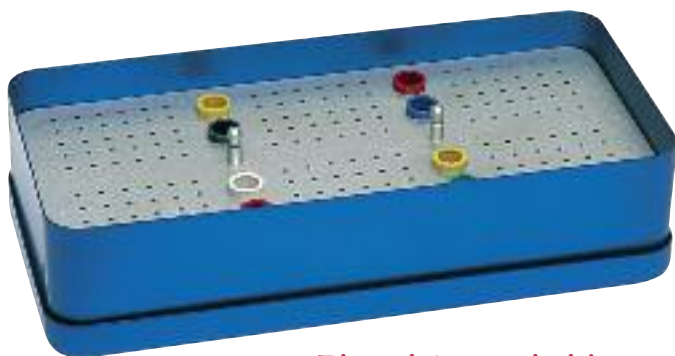

The ultimate holder

ENDO ECO

• Ref. 180195 - Colours 1 2 3 4 5 - Anodised aluminium.

Size 22x10,5x5 cm - 180 holes for endodontic instruments, 8 autoclavable plastic cups - Please ensure any solution used is checked for compatibility with aluminium.

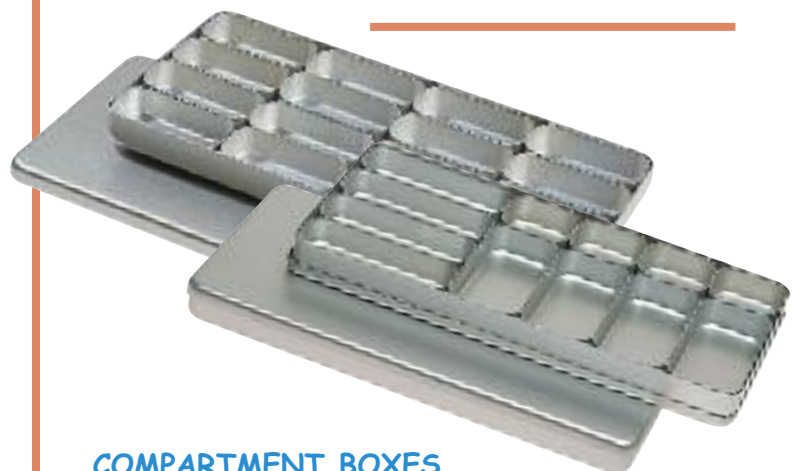

COMPARTMENT BOXES

Anodised aluminium - Size 22x10,5x2 cm

Colour 1 only - Please ensure any solution used is checked for compatibility with aluminium.

- Compartment Boxes 12 removable comp.Ref. 180100
- Compartment Boxes 16 removable comp.Ref. 180101

Endodontic stands "New Generation"

Aluminium products : refer to instructions for use



MINI GRIPP

ALU • Ref. 180250 - Size : Ø 4 cm - H. 3,5 cm
Colours 1 2 3 4 5 - Anodised aluminium. Replaceable gauze system, cup for disinfection liquid. Please ensure any solution used is checked for compatibility with aluminium.

STAINLESS STEEL • Ref. 182400 - Size Ø 4 cm H. 3,5 cm - Stainless steel & Teflon. Ideal for collecting used endodontic instruments and proceeding to decontamination. Resistant to any sterilization and cleaning process.



ENDOMODULE

ALU • Ref. 180130 - Size 13,5x5,5x1,8 cm - Colours 1 2 3 4 - Anodised aluminium - Please ensure any solution used is checked for compatibility with aluminium.

STAINLESS STEEL • Ref. 182130
Size 13,5x5,5x1,8 cm - Resistant to any sterilization and cleaning process



ENDODISPENSER 8 holes. With sterimeter
Size 6,8 x 4,6 x 1,7 cm • Ref. 182210



ENDODISPENSER 12 holes. With sterimeter
Size 9 x 5 x 1,7 cm • Ref. 182260

Stainless steel and teflon - Can be rotated in any direction. Ideal for use in ultrasonic baths, cleaners, disinfectors (can be placed in autoclave pouches). Colours 8 2 4 5 - Silicone cursor for counting the number of times used.



ENDO RING
Endo Ring - Set of 2
Size 3,9 x 1,2 cm - Ref. 182110



new

Foam refills
Set of 40
Ref. 182116

ENDO RING PLUS
The foam pad allows you to keep those instruments in use for a procedure easily accessible - Size 4 x 3,2 cm - Ref. 182115

Stainless steel ring with a graduated ruler and stop attached. Designed to measure the working length of endodontic hand instruments. Indelibly printing on using a laser. Can be swiveled to suit any desired direction. Can be used for right or left hand

Will support any type of decontamination and sterilization.

Sterilization «Cassettes»

Precise dimensions
on request

Stainless steel and silicone.
Can be used with all known
decontamination, cleaning
and sterilization
processes. Allow to
store and arrange
instruments for most
procedures. Safest option for instrument
logistics. Save assistant time.



Removable cover
New twist lock system (1 rotating knob)



CASSETTES 18x14

Size 18,3 x 14 x 3,4 cm

- Ref. 182066 - For 8 instruments
- Ref. 182056 - For 10 instruments
(available on request)

Secured storage
for the
instruments



CASSETTES 18x10

Size 18,5 x 11 x 3,4 cm

- Ref. 192054 - For 6 instruments



CASSETTES 18x7

Size 18,5 x 7 x 3,4 cm

- Ref. 182069 - For 4 instruments
- Ref. 182079 - Version for 2
hand pieces (available on request)



CASSETTES 28x18

Size 28 x 18 x 3,4 cm - Removable cover

New twist lock system (2 rotating knobs)

Holes in the edges for better cleaning process

- Ref. 182068 - With instrument holder for 16 instruments
(all sizes).
- Ref. 182058 - With instrument holder for 20 instruments
- Ref. 182087 - With instrument holder for 10 instruments
(all sizes), blocked off area for storage of accessories.

New Models

Flat Cassettes



CASSETTE 18x13

Size 18,2 x 13 x 2,5 cm

For 10 instruments

- Blue silicone  Ref. 182062-2
- Green silicone  Ref. 182062-4



CASSETTES 18x9

Size 18,2 x 9,5 x 2,3 cm

For 7 instruments

- Blue Silicone  Ref. 182055-2
- Green Silicone  Ref. 182055-4



CASSETTE 18x6

Size 18 x 6 x 2,5 cm

For 5 instruments

- Blue silicone  Ref. 182063-2
- Green silicone  Ref. 182063-4



MULTI CASSETTE 18 x 20

New Model

• Ref. 182057 - Size 18 x 20,5 x 3,4 cm - Removable cover

New twist lock system (1 rotating knob)

Silicone holder for 8 instruments (all sizes), blocked off
area for storage of accessories.

UltraLight Cassettes

Precise dimensions
on request



ULTRALIGHT CASSETTE 28 X 18

• Ref. 182037 - Size 28 x 18 x 3,4 cm
Removable cover. **New Twist Lock system (2 rotating knobs)**. Silicone holder for 12 instruments, blocked off area for storage of accessories such as : Endo pro, Endo dispenser, Bur clips, Plug'in etc...

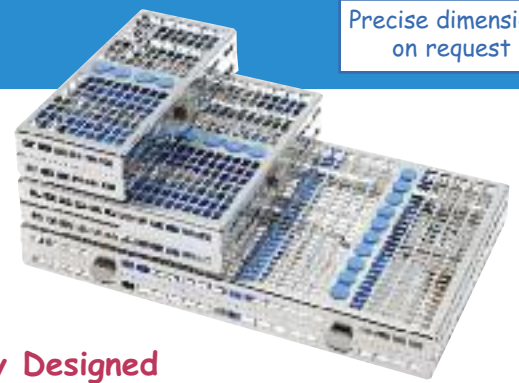

Specially Designed for Washer Disinfector use

These brand new cassettes with a lattice style have been created specifically for use in washer disinfectors.

The cassettes are very strong but light and have been designed for use with all disinfection and cleaning solutions, as well as all sterilization processes.

Made of Stainless Steel, they are equipped with silicone inserts shaped to hold most instruments securely.

The removable cover allows space to be saved on the bracket table. The new «Twist Lock System» is very reliable and easy to use.

Available in colours **2 3 4 5**



ULTRALIGHT CASSETTE 18 X 14

• Ref. 182036 - Size 18,5 x 14 x 3,4 cm
Removable cover. **New twist lock system (1 rotating knob)** - Silicone holder for 10 instruments.



ULTRALIGHT CASSETTE 18 X 7

• Ref. 182039 - Size 18,5 x 7,5 x 3,4 cm
Removable cover. **New twist lock system (1 rotating knob)** - Silicone holder for 5 instruments.

EASY CLIP has a retractable clip with a fixed hinge, so it can never be lost

Moving the arm fully back opens the cassette for easy placement and access of instruments. Then a simple click and your instruments are held in place securely. Made of stainless steel and silicone, EASY CLIPS are electropolished to give a bright shiny surface finish.

EASY CLIPS can be used in all washer disinfectors and ultrasonic baths with all known solutions, and then sterilized at 134° unwrapped pouched or in a full hospital wrap.

5 types are available (for 3, 5, 10, 15 and 20 instruments),

4 colours **2 3 4 5**



Silicone Refills
p.34-35



EASY CLIP 3

• Ref. 182903 - Size 18 x 5,5 x 2,5 cm
Silicone holder for 3 instruments
(Flexi Clip version available on request)



EASY CLIP 5

• Ref. 182900 - Size 18 x 8,5 x 2,5 cm
Silicone holder for 5 instruments
(Flexi Clip version available on request)



EASY CLIP 10

• Ref. 182910 - Size 18 x 12,8 x 2,5 cm
Silicone holder for 10 instruments
(Flexi Clip version available on request)



EASY CLIP 15

• Ref. 182912 - Size 20,7 x 18 x 2,5 cm
Silicone holder for 15 instruments
(Flexi Clip version available on request)



EASY CLIP 20

• Ref. 182920 - Size 25 x 18 x 2,5 cm
Silicone holder for 20 instruments
(Flexi Clip version available on request)

> **INNOVATIVE IDEA :**

Easy Tray has a retractable clip with a fixed hinge, so it can never be lost

Stainless steel and silicone. Can be used with all known decontamination, cleaning and sterilization processes. Electropolishing gives a bright, shiny, smooth surface finish. More than a tray, simpler than a cassette. With Easy Tray you can see your instruments and know they and you are safe.

6 variations are available in

4 different colours **2 3 4 5**



Easy Tray 18 x 5

1/6 DIN

Size 18 x 5 x 3 cm

- Ref. 183704 for 4 instruments
- Ref. 183703 for 3 instruments



Easy Tray 18 x 14

1/2 DIN

• Ref. 183710 - Size 18 x 14 x 3 cm

For 10 instruments + clear area for accessories



Easy Tray 21 x 18

3/4 DIN

• Ref. 183715 - Size 21 x 18 x 3 cm

For 15 instruments + clear area for accessories



Easy Tray 18 x 7

1/4 DIN

• Ref. 183700 - Size 18 x 7 x 3 cm

For 5 instruments



Easy Tray 18 x 10

1/3 DIN

• Ref. 183705 - Size 18 x 10 x 3 cm

For 5 instruments + clear area for accessories

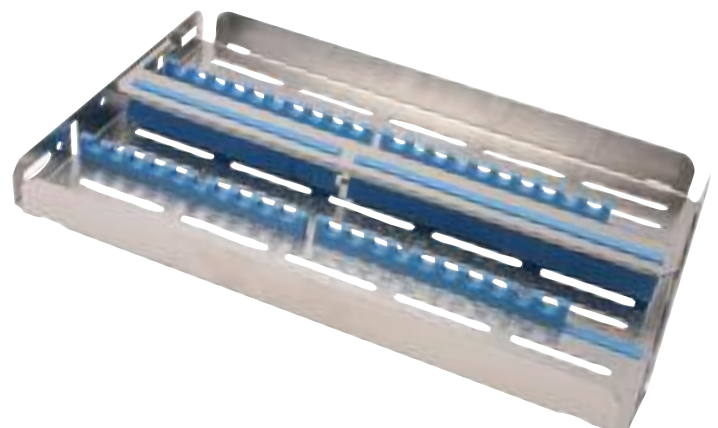

Easy Tray 28 x 18

DIN

• Ref. 183720 - Size 28 x 18 x 3 cm

For 20 instruments + clear area for accessories

Sterilization : «Ergo Clips»

Ergo Clip allows you to store and arrange your instruments for most procedures. The ergonomic shape allows easier handling of the instruments: Thanks to the self locking and removable steel and silicone holder, a simple click and your instruments are held in place whatever their diameter. These systems save assistant time and are the safest option for instrument logistics. Made of stainless steel and silicone, Ergo Clips are ideal for use in ultrasonic baths, thermo disinfectors and autoclaves. (They can be placed in autoclave pouches or wrapped).



ERGO CLIP 10

Size 18,4 x 15 x 2,5 cm

Silicone holder for 10 instruments.

- Blue silicone **2**Ref. 182710-2
- Green silicone **4**Ref. 182710-4
- Model with full cover - Blue silicone **2**Ref. 182750-2



ERGO CLIP 3

Size 18,4 x 8 x 2,5 cm

Silicone holder for 3 instruments.

- Blue silicone **2**Ref. 182703-2
- Green silicone **4**Ref. 182703-4



ERGO CLIP 15

Size 23 x 18,4 x 2,5 cm

Silicone holder for 10 instruments and clear area for accessories.

- Blue silicone **2**Ref. 182712-2
- Model with full cover - Blue silicone **2**Ref. 182752-2



ERGO CLIP 5

Size 18,4 x 11 x 2,5 cm

Silicone holder for 5 instruments.

- Blue silicone **2**Ref. 182700-2
- Green silicone **4**Ref. 182700-4
- Model with full cover - Blue silicone **2**Ref. 182753-2



ERGO CLIP 20

Size 28,8 x 18,4 x 2,5 cm

Silicone holder for 20 instruments.

- Blue silicone **2**Ref. 182725-2
- Model with full cover - Blue silicone **2**Ref. 182751-2
- Silicone holder for 10 instruments and wave silicone for accessoriesRef. 182725-2

Implantology : Modulis Cassettes

Customize your Implant Kit !

1/ Select the size of the cassette :



Modulis Cassette 4

Size 10 x 7,5 x 2,3 cm
• Ref. 500904

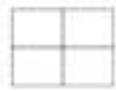

Modulis Cassette 8

Size 20 x 7,5 x 2,3 cm
• Ref. 500908

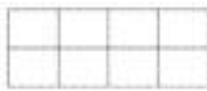

Modulis Cassette 12

Size 20 x 11 x 2,3 cm
• Ref. 500912



2/ Select the modules to customize inside :

Single modules Size 5 x 3,7 x 2 cm



4 Plugs Module
• Ref. 500939



3 Tubes Module
• Ref. 500938



2 Tubes Module
• Ref. 500937



Compartment module
• Ref. 500935

Double modules

Size 5 x 3,7 x 2 cm

Size 5 x 3,7 x 2 cm

Size 10 x 3,7 x 2 cm

Quadruple modules

Size 10 x 7,4 x 2 cm

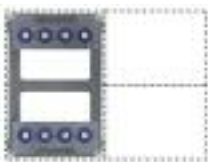

8 Plugs Module
• Ref. 500934

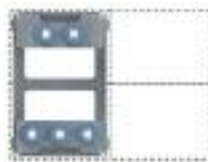

5 Tubes Module
• Ref. 500933

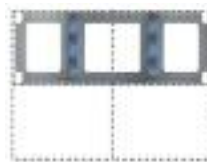

Ratchet Holder Module
• Ref. 500932

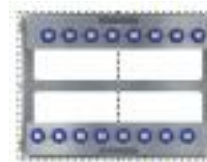

16 Plugs Module
• Ref. 500931

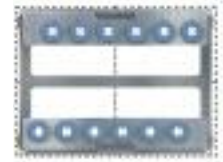

12 Tubes Module
• Ref. 500930

3/ Get your own implant tool kit



Implantology Kits

Implantology Kits allow implant accessories to be easily sterilized in the Kit ready for immediate use. Made of stainless steel and silicone, the Implantology Kits are manufactured in «High Quality» materials. The Implantology Kits are resistant to any sterilization process. The kits must be open to be used in a thermal disinfectant. Silicone plugs with different diameters allow storage of each type of instrumentation. **The silicone holders keep all instruments secure in the kit.**



IMPLANT PLUG'IN N°1

• Ref. 500401 - Size 10 x 5 x 4 cm

It allows you to store 6 instruments and 1 ratchet (maximum length for ratchet : 9 cm)



IMPLANT PLUG'IN N°2

• Ref. 500501 - Size 15 x 4,5 x 5 cm

It allows you to store 13 instruments and 1 ratchet (maximum length for ratchet : 10 cm). 1 stainless steel removable compartment with holes in the cover for an efficient cleaning process



IMPLANTOLOGY KIT N°1

• Ref. 500561 - Size 10 x 9 x 5 cm

8 silicone tubes - 2 rotating teflon holders - 1 stainless steel removable compartment



IMPLANTOLOGY KIT N°1

With special holder for ratchet

• Ref. 500571 - Size 10 x 9 x 5 cm

14 silicone tubes - 1 holder for ratchet (maximum length for ratchet : 9 cm) - 1 stainless steel removable compartment

Implantology Kits

new

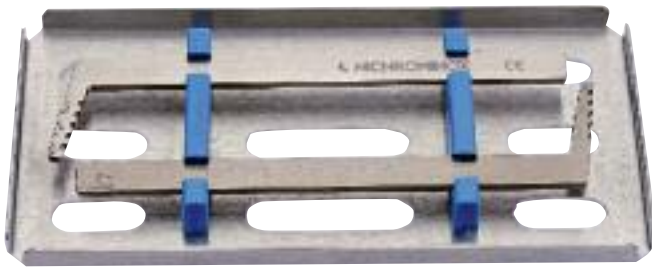

EASY GAUGE

- Ref. 500550
- Size 12,7 x 6,6 x 0,7 cm

Place your implants with high accuracy



The correct alignment first time is very important for a successful prosthetic treatment. No more guessing, no surgical guide or bulky devices...Ensures the perfect alignment of the implant in relation to the existing teeth, or of an existing implant. Easy gauge is the perfect tool for a very accurate first hole. Easy to use thanks to its notched laser marked ruler. Allows the user to change their mind very easily. Not large, making it more comfortable in the patients mouth. Easy Gauge is versatile and needs no other tool. Can be used with any implant system, any implant diameter. Stainless steel rulers (1 distal + 1 mesial), stored in a stainless steel tray fitted with silicone holders. It can be used with any type of disinfection, cleaning and sterilization process.

Silicone Refills p.34-35



IMPLANTOLOGY KIT N°2

With special holder for Ratchet

- Ref. 500631 - Size 15 x 8,5 x 5 cm - 24 silicone tubes
- 1 holder for ratchet (maximum length for ratchet : 9,5 cm)
- 1 stainless steel removable compartment

new

Ergonomic and compact



IMPLANT CASSETTE

- Ref. 500301 - Size 10 x 8 x 2 cm
- For 8 instruments and 1 ratchet
- (maximum length for ratchet : 9,5 cm)

Stainless steel and silicone. Will support any type of disinfection, sterilization and cleaning processes. An innovative shape, making it different from the traditional Implant boxes with rotating holder for the drills and various accessories. When the cassette is open, the holder stands vertically, so that you can see and remove the instruments very easily. When closing the cassette, the holder is laid horizontally, for a more compact cassette. For storage of 8 varied instruments + 1 ratchet. Can be used in ultrasonic baths, thermo disinfectors and autoclaves. Can be placed in autoclave pouches or wrapped.

IMPLANTOLOGY MINI KIT N°5

T Model - Ref. 500850-T

- Size 8 x 5,5 x 4 cm
- 12 silicone variable tubes for accessories with diameters between 2 mm and 6,5 mm



IMPLANTOLOGY MINI KIT N°5

P Model - Ref. 500850-P

- Size 8 x 5,5 x 4 cm
- 12 silicone plugs for burs and drills



IMPLANTOLOGY MINI KIT N°5

C Model - Ref. 500850-C

- Size 8 x 5,5 x 4 cm
- 1 silicone ratchet holder (maximum length for ratchet : 7 cm) and stainless steel removable compartment



«Special for small Instruments»

Divided Cassettes

The first cassettes for storage and sterilization of small dental items (eg, bands, brackets or implants components...) and also for longer instruments (eg. Endodontic instruments, implantology drills.) Makes organisation easy. Stainless steel and silicone. Available in 3 sizes which can be fitted with 2 different types of internal silicone. Resistant to any sterilization and cleaning processes. **Must be open to be used in a thermal disinfectant.**

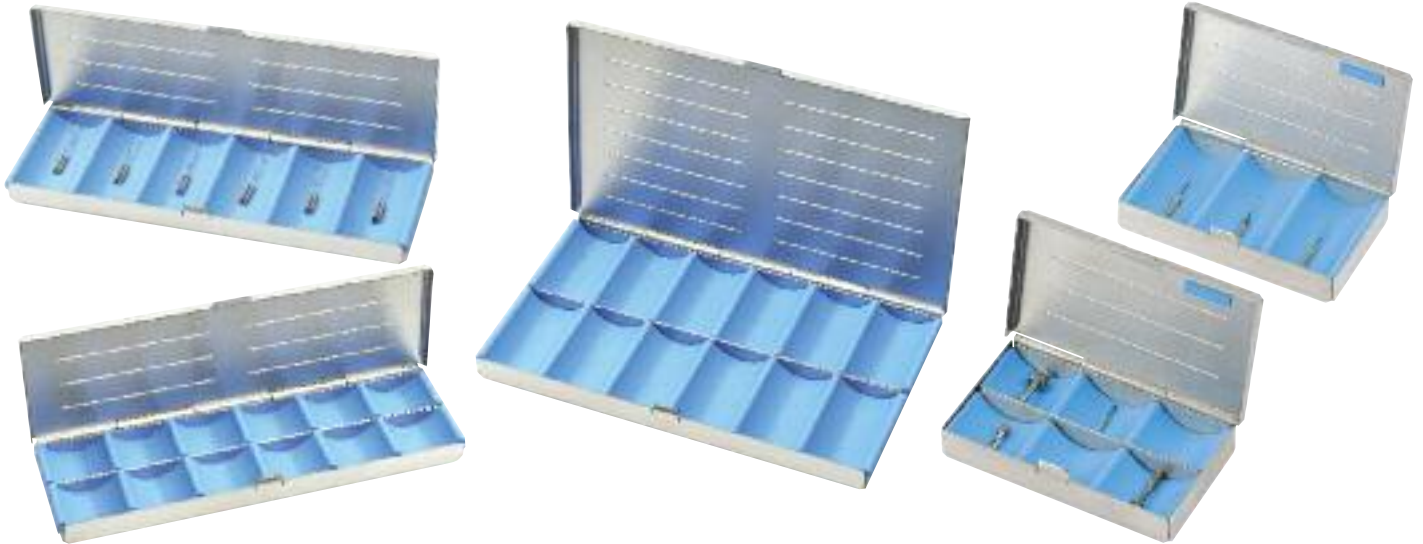

CASSETTES 21 X 6

Size 21x6x2 cm

- 6 compartments :Ref. 182096
- 12 compartments :Ref. 182095

CASSETTES 21 X 12

Size 21x12x2 cm

- 12 compartments :Ref. 182076
- 24 compartments :Ref. 182075

CASSETTES 11 X 6

Size 11x7x2 cm

- 3 compartments : Réf. 182094
- 6 compartments :Réf. 182093

Micro Cassettes

Stainless steel and silicone - The ultimate cleaning and sterilizing container for all of those instruments and accessories that don't already have their own specific holder. Resistant to sterilization process. Micro cassettes for clamps suitable for use in thermal disinfectant. **Must be open to be used in a thermal disinfectant.**



MICRO CASSETTE 1

Size 7,4x4,5x2 cm

- Ref. 182060

MICRO CASSETTE 2

Size 7,4x5,9x2,4 cm

- Ref. 182070

MICRO CASSETTE 3

Size 4 x 5,5 x 2 cm

- Ref. 182040



N° 1 Size 8,4 x 6 x 2,5 cm

- Ref. 182090



N° 2 Size 5,7 x 4,8 x 2,7 cm

- Ref. 182092

MICRO CASSETTE FOR CLAMPS

Intra-oral Photography : «The Essentials»



Glass Mirrors

These mirrors are made of **float Glass**, with a thickness of 3mm. They are front surface coated with pure Chromium, using a sputtering vacuum process. No double image and the glass is perfectly flat giving **distortionless images**. Mirrors are reversible even for asymmetrical shapes. Sterilized by any process up to 220°

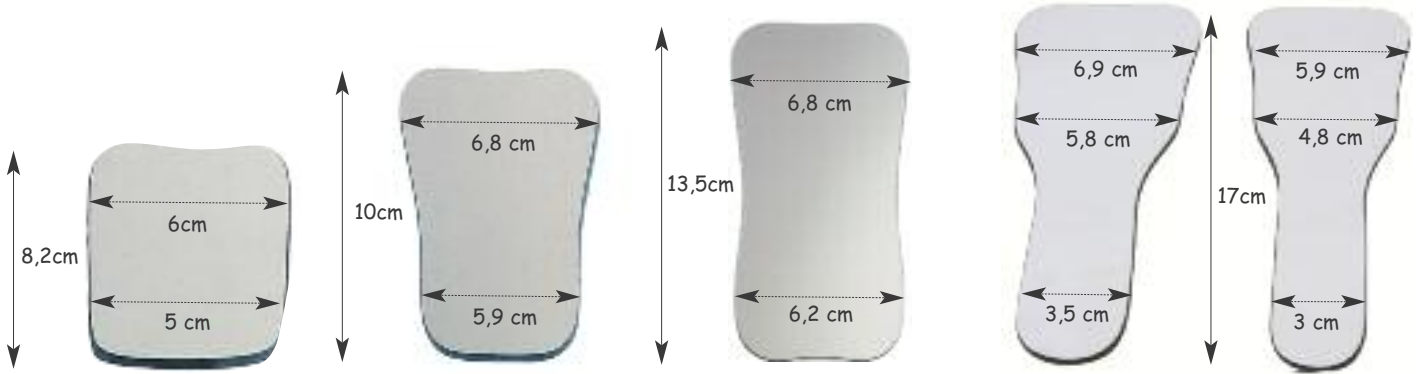

SMALL PALATAL
• Ref. 190761
Occlusal views

LARGE PALATAL
• Ref. 190760
Occlusal views

PALATAL XL
• Ref. 190784
Occlusal views
1 end adult / 1 end child

UNIVERSAL LARGE
• Ref. 190785

UNIVERSAL SMALL
• Ref. 190786

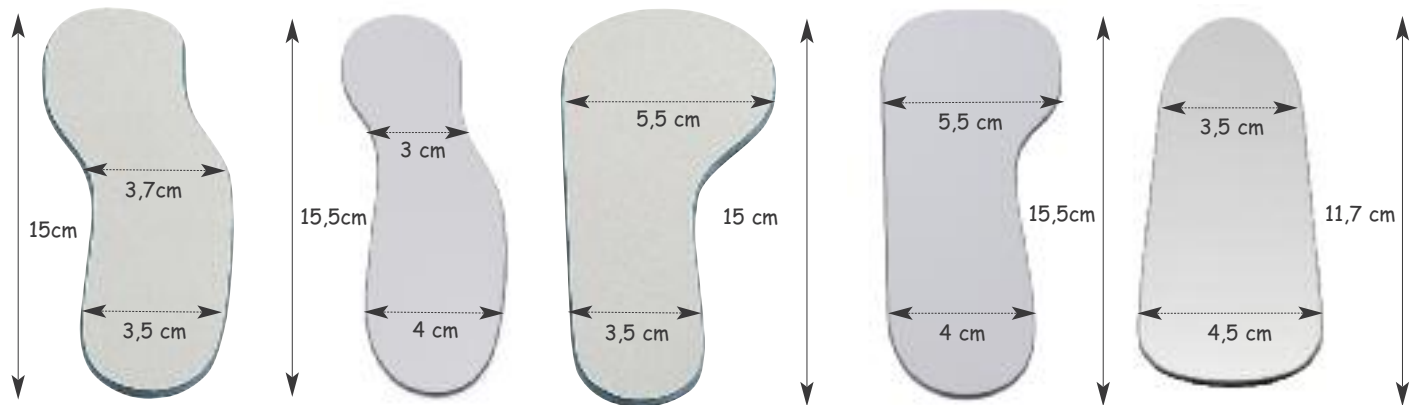

LATERAL C
• Ref. 190762
Buccal views

LATERAL S
• Ref. 190763
Buccal views

LINGUAL P
• Ref. 190764
Lingual views

LINGUAL G
• Ref. 190765
Lingual views

LATERAL T1
• Ref. 190767
Buccal views

MIRRORS WITH REMOVABLE HANDLE

These mirrors are made of **float Glass**, with a thickness of 3 mm
Stainless steel handle



• Ref. 190792 - Palatal mirror
Size of the mirror 10 x 7 cm



• Ref. 190791 - Lateral T1 mirror
Size of the mirror 11,7 x 4,5 cm

Intra-oral Photography: «The Essentials»

ALUMINIUM CONTRASTORS

Contrastors

SILICONE CONTRASTORS



Available in 2 styles, black anodised aluminium or our new black silicone coated scratch proof contrastor. The contrastors are suitable for normal and digital photography. They give contrast to your images and eliminate those elements not required in the picture. The Upper Contrastor is perfect for profiles. It allows you to hide the upper lip, including moustache and nose.



Set of 2 palatal contrastors
(1 large + 1 small)
• Ref. 190780



Palatal large contrastor
Ref. 190781
Palatal small contrastor
Ref. 190782



Set of 2 upper contrastors
(1 large + 1 small)
• Ref. 190776



Upper large contrastor
Ref. 190777
Upper small contrastor
Ref. 190778

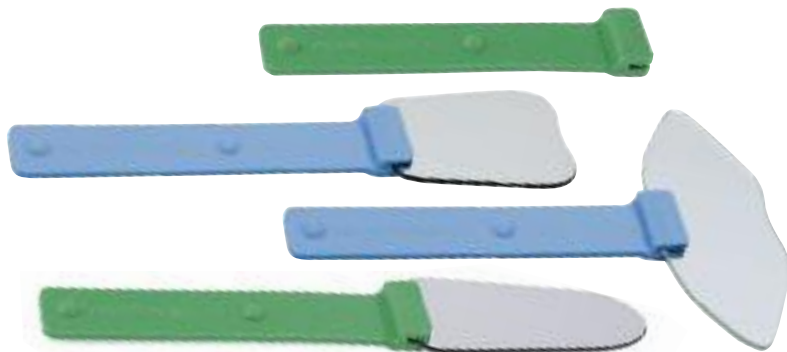

SILICONE MIRROR HANDLE

• Ref. 190796 - Available in blue and green colour - Flexible stainless steel blade encased in silicone. Unbreakable. Can be bent with your hands in any position. Avoid finger prints and smudges on the mirrors. Holds the mirrors firmly in place without any damage. Allows you to use both sides of the mirror. Can be used with any type of cleaning, decontamination and sterilization. **Mirror sold separately (see p.21)**



METALLIC BLADES

- Ref. 190711 - N°1 Small
- Ref. 190712 - N°2 Large

Mirror polished effect. Their specific shape gives very good results. For occlusal photos use the large end. For lingual photos use the small end.

Intra-oral Photography: «The Essentials»

Photos Kits

Stainless steel and silicone. Allow you to store and to sterilize your accessories for Intra Oral Photography. Sterilization in an autoclave (please refer to components instructions for use).

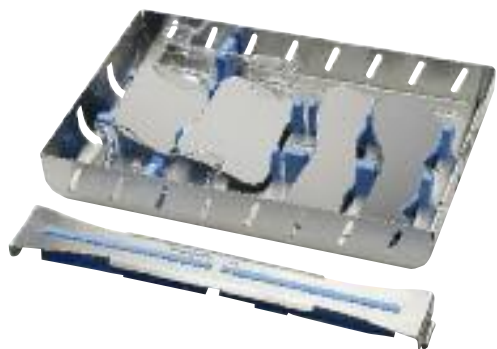

PHOTO KIT N°2

Size 29 x 18,3 x 3,7 cm

- Complete KitRef. 182735 (4 mirrors + 2 plastic retractors)
- Empty KitRef. 182730



PHOTO KIT N°1

Size 19,8 x 16,5 x 3,7 cm

- Complete KitRef. 182734 (3 mirrors)
- Empty KitRef. 182731

Thanks to the self locking and removable steel and silicone holder, a simple click and your mirrors are held in place and kept safe.

Photo Cassettes

Stainless steel and silicone. Allow you to store and to sterilize your accessories for Intra Oral Photography. Sterilization in an autoclave (please refer to components instructions for use).



PHOTO CASSETTE N°1

Size 18 x 15 x 4,7 cm

- Complete CassetteRef. 182739 (3 mirrors + 1 silicone handle)
- Empty CassetteRef. 182737



PHOTO CASSETTE N°2

Size 18 x 15 x 4,7 cm

- Complete CassetteRef. 182769 (4 miroirs)
- Empty CassetteRef. 182767

New Design. New twist lock system (1 rotating knob)



Solo Cassettes

Increase the life of your Photographic Mirrors. **Solo Cassettes** protect your Photographic Mirrors during any cleaning and sterilization process. Silicone strips put no pressure on the mirrors for complete penetration of the washing solution.

Mirrors sold separately (see p.21)



SOLO CASSETTE N°1

Size 12 x 8,5 x 1,3 cm
• Ref. 182746

For the storage of : 1 large Palatal or 1 small Palatal or 1 Lateral T1



SOLO CASSETTE N°2

Size 16,2 x 7 x 1,3 cm
• Ref. 182747

For the storage of : 1 Lateral C or 1 Lateral S or 1 Lingual P or 1 Lingual G



SOLO CASSETTE N°3

Size 18,6 x 8,4 x 1,3 cm
• Ref. 182748

For storage of : Universal Mirrors (large or small) or Palatal XL

Various Accessories



TONGUE PROTECTORS

Tongue and Cheek protection

Easy access to the whole arch. Allows you to use a handpiece at any angle safely.

- Ref. 190514 - Without Mirror - Set of 2 - right hand and left hand
- Ref. 190515 - With high quality mirrors - Per Unit - Both sides model

CHEEK RETRACTORS



Plastic retractors

- Set of 2 - Ref. 072700
- To retract cheeks and have a better view. Double ended. Sterilization in an autoclave (please refer to instructions for use)



Stainless steel retractor

- Set of 2 - Ref. 072600
- Made of non reflective stainless steel wire. One large and one small end, allowing cheek retraction to give a better view.



EXAMINATION MIRRORS

- Set of 6 - Ref. 193510

6 colours 1 2 3 4 5 6

Aluminium anodised handles - Mirror Ø 2 cm

Sold as a set of 6 with assorted coloured handles.



PARALLELISM MIRROR

- Ref. 190750 - sold with handle

The Parallelism mirror is a high quality front surface mirror with laser cut lines in the surface.

Size of the mirror 4.5 x 2.9 cm



DENTAL MIRRORS Ø 4 & 5 cm

For Intra-Oral Photography or for Motivation

Sold with handle

- Miroir Ø 4 cm.....Ref. 190772
- Miroir Ø 5 cm.....Ref. 190773



SILICONE CODE RING

For identifying and organising instruments

- Ref. 190202 - 4 colours 2 3 4 5 - Box of 50 pieces
- Sterilization up to 240°

Various Accessories



METALLIC SPLINTING GRIDS

- Ref. 190650
- Stainless steel
- Box of 10 pieces (1 meter)



ASSORTMENT SCREW POST BOX

- Nickel Chrome alloy (18 10) retentive notches
- Post Box 9/10 to 14/10Ref. 119700
- Assorted drills boxRef. 119800
- For refills (please refer to price list)

STRAIGHT WIRES B3

- Nickel Chrome alloy (18 10)
- For diameters available : please refer to price list
- Straight wires B3 - Length 15 cmRef. 119400
- Straight wires B3 - Length 30 cmRef. 119500
- Calibrated tubes for straight wires B3 :
- Tubes for straight wires B3 - Length 15 cm.....Ref. 120100
- Tubes for straight wires B3 - Length 30 cm.....Ref. 120200



BITE REGISTRATION TRAYS RIGID

- This bite tray is designed to compress the impression material.
- The set of 2Ref. 190150



STAPLING SET

- Ref. 119600
- This set is designed for the placement of the U staples of Dr Abjean and Dr Genon :
- 1 teflon organizer with a stainless steel size converter.
- 1 set of 4 instruments and 6 staples of each size : 1.75, 2.00, 2.25, 2.50, 2.75, 3.00, 3.25, 3.50, 3.75, 4.00 mm.
- Sterilization box made of white Teflon with a stainless steel cover.
- For more information, please refer to lecture Dr ABJEAN and Dr GENON surgical technique.



PARALLELING GAUGE

- Ref. 190530
- To be used with the stapling set. This instrument is designed to measure the gap of 2 holes for the selection of the staples for splinting the front teeth.



LIGATURE WIRES

- Nickel Chrome alloy (18 10)
- Ø 2,5/10 mm (Roll of 15 m).....Ref. 119325
- Ø 3/10 mm (Roll of 15 m)Ref. 119203
- Ø 4/10 mm (Roll of 15 m).....Ref. 119204
- Ø 5/10 mm (Roll of 15 m).....Ref. 119205

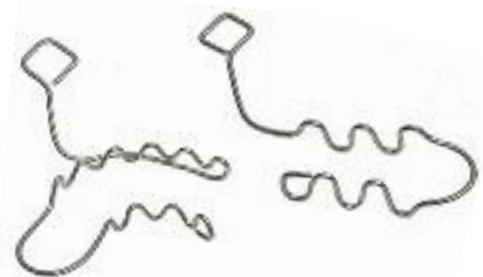

WIRE BITE TRAYS

- Wire bite tray made of stainless steel wire makes the handling of the impression material easier.
- Boxes of 10 piecesRef. 190110

Retractors

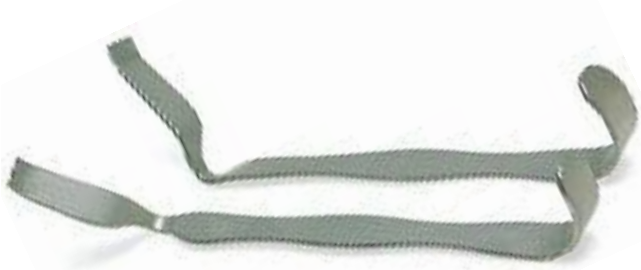

LOWER THIRD MOLAR RETRACTOR

• Sold as a pair (left and right)Ref. 074000

Can be used for lower wisdom back teeth . Claws for support.



UPPER THIRD MOLAR RETRACTOR

• Sold as a pair (left and right)Ref. 071700

Can be used for upper wisdom back teeth . Claws for support.



FLAP RETRACTOR

• Width 8 mmRef. 071108

• Width 12 mmRef. 071112

Can be used for extraction of lower and upper wisdom back teeth . Claws for support.



GINESTET TYPE RETRACTOR

• Sold as a pair (left and right)Ref. 072400

Can be used for lower wisdom back teeth . Claws for support.



DAUTREY TYPE RETRACTOR

Can be used for wisdom back teeth. Very smooth edges.

Available in 2 sizes :

• Short H.6 and 4,5 cmRef. 072200

• Long H.9 and 7,5 cmRef. 072201



FARABEU F TYPE RETRACTOR

• Set of 2Ref. 072100

This retractor is multi-purpose, it can be used for all types of oral surgery.

Retractors and Mouth Props



MALLEABLE RETRACTORS

• Set of 3Ref. 071000

3 widths : 10, 15 and 20 mm - Can be easily bent with fingers or pliers to the shape you require.

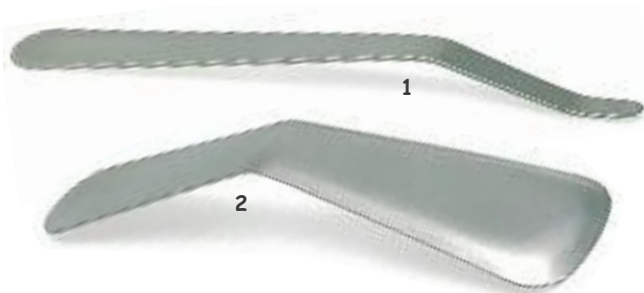

RETRACTOR FOR LINGUAL APPROACH (1)

• Set of 2Ref. 070800

This retractor is design for the lingual approach of the wisdom lower back teeth

TONGUE RESTRAINER (2)

• Set of 2Ref. 072000

It allows you to gently keep the tongue down.



MOUTH GAGS

Available in 2 sizes. Includes a slightly concave blunt blade fixed with a bolt's to push the tongue aside.

• Adult standart sizeRef. 070000

• Small sizeRef. 070001



UNIVERSAL RETRACTOR

• The retractor.....Ref. 075000

For all types of oral surgery.



"S" SHAPE RETRACTOR

• The retractorRef. 072500

Retract both a flap and cheek without trauma. Choice of 2 ends of different widths 12 and 20 mm.

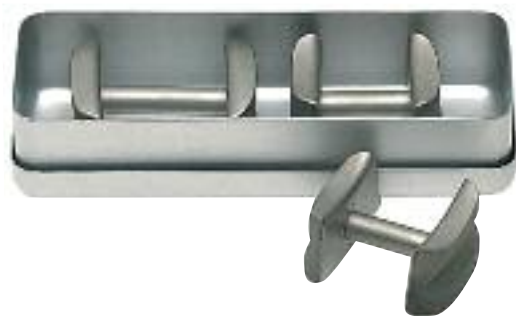

MOUTH PROPS

• The set of 2 in an aluminium boxRef. 070300

Non reflective stainless steel. The patient will bite on a soft silicone surface to keep the mouth open. Available in 2 sizes : 15 and 25 mm.

Stainless Steel Trays : Safety, Hygiene



STAINLESS STEEL TRAYS

Large size 28 x 18 cm

Stainless steel

- Tray 28 x 18 x 1,9 cmRef. 182450
- Cover 28 x 18 x 2,5 cmRef. 182451
- Instrument holder (11)Ref. 182452



STAINLESS STEEL TRAYS

Small size 18 x 14 cm

Stainless steel

- Tray 18 x 14 x 1,9 cmRef. 182460
- Cover 18 x 14 x 2,5 cmRef. 182461
- Instrument holder (7)Ref. 182462



STAINLESS STEEL PERFORATED TRAYS

Large size 28 x 18 cm

Stainless steel

- Tray 28 x 18 x 1,9 cmRef. 185450
- Cover 28 x 18 x 2,5 cmRef. 185451
- Instrument holder (11)Ref. 182452



STAINLESS STEEL PERFORATED TRAYS

Small size 18 x 14 cm

Stainless steel

- Tray 18 x 14 x 1,9 cmRef. 185460
- Cover 18 x 14 x 2,5 cmRef. 185461
- Instrument holder (7)Ref. 182462



STAINLESS STEEL RACKS 28 x 18

For 6 trays 28 x 18 with covers

- size 30 x 19 x 27 cmRef. 182455 (empty)

Can be wall mounted



STAINLESS STEEL RACKS 18 x 14

For 6 trays 18 x 14 with covers

- Size 19 x 16 x 27 cmRef. 182465 (empty)

Can be wall mounted

Coloured Aluminium Trays

Aluminium products : refer to instructions for use

6 Colours 1 2 3 4 5 6 - Covers : silver colour only

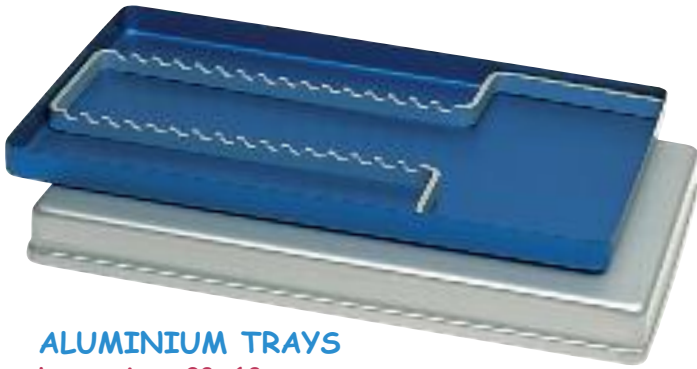

ALUMINIUM TRAYS

Large size : 28x18 cm

Anodised aluminium - Colours 1 2 3 4 5 6 Please ensure any solution used is checked for compatibility with aluminium.

- Tray 28 x 18 x 1,9 cmRef. 181450
- Cover 28 x 18 x 2,5 cmRef. 181451
- Instrument holder (16)Ref. 181452



ALUMINIUM TRAYS

Small size : 18x14 cm

Anodised aluminium - Colours 1 2 3 4 5 6 Please ensure any solution used is checked for compatibility with aluminium.

- Tray 18 x 14 x 1,9 cmRef. 181460
- Cover 18 x 14 x 2,5 cmRef. 181461
- Instrument holder (10)Ref. 181462

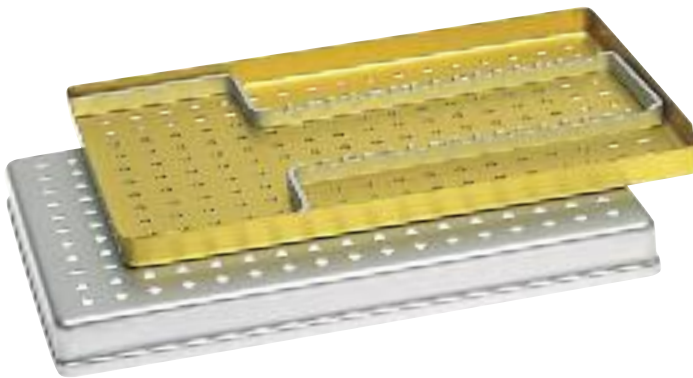

PERFORATED ALUMINIUM TRAYS

Large size : 28x18 cm

Anodised aluminium - Colours 1 2 3 4 5 6 Please ensure any solution used is checked for compatibility with aluminium.

- Tray 28 x 18 x 1,9 cmRef. 184450
- Cover 28 x 18 x 2,5 cmRef. 184451
- Instrument holder (16)Ref. 181452



PERFORATED ALUMINIUM TRAYS

Small size : 18x14 cm

Anodised aluminium - Colours 1 2 3 4 5 6 Please ensure any solution used is checked for compatibility with aluminium.

- Tray 18 x 14 x 1,9 cmRef. 184460
- Cover 18 x 14 x 2,5 cmRef. 184461
- Instrument holder (10)Ref. 181462



ALUMINIUM RACK 28x18

For 6 trays and covers 28 x 18 cm

Short size loading :

- Size 30 x 19 x 27 cmRef. 181455 (empty)

Long size loading :

- Size 19 x 30 x 27 cmRef. 181456 (empty)

Can be wall mounted



ALUMINIUM RACK 18x14

For 6 trays and covers 18 x 14 cm

- Size 19 x 16 x 27 cmRef. 181465 (empty)

Can be wall mounted

Aluminium Trays and Accessories

Aluminium products : refer to instructions for use



ALUMINIUM TRAYS

Anodised aluminium - Colours **1 2 3 4 5 6** - Please ensure any solution used is checked for compatibility with aluminium.

- Size : 20 x15 x 2 cmRef. 181480
- Size : 20 x10 x 2 cmRef. 181470

STAINLESS STEEL TRAYS

Stainless steel - High quality
Perfect for your exam sets.

- Size : 20 x15 x 2 cmRef. 182480
- Size : 20 x10 x 2 cmRef. 182470



ALUMINIUM RACKS

For 6 trays 20 x 15

- Size 16 x 20 x 18,5 cmRef. 181485 (empty)

For 6 trays 20 x 10

- Size 10,3 x 20 x 18,5 cmRef. 181475 (empty)



STAINLESS STEEL RACKS

For 6 trays 20 x 15

- Size : 21 x 15,8 x 18,2 cmRef. 182485 (empty)

For 6 trays 20 x 10

- Size : 20,6 x 10,2 x 18,2 cmRef. 182475 (empty)



ALUMINIUM TUBS

Colours **1 2 3 4**

Made of aluminium, the Tub is recommended for use as a portable operator drawer. Ultra light, it may be of help to the assistant. One tub is recommended for each different type of procedure.

Tubs can be fitted with tub divider and arranged in an aluminium rack.

Ensure any solution used is checked for aluminium.

- Alu. Tub Size 33,5 x 23,5 x 5,2 cmRef. 181510
- Tub dividerRef. 181520
- Empty rack. Size 34 x 24 x 41 cmRef. 181525

Safety, Hygiene, sterilization

Aluminium Steri Trays

Anodised aluminium - Colour 1 only. Multiperforated cover with lockable system. With replaceable filter system. Silicone heat resistant lockable seal (230°). Aluminium instrument holder.

Paper filters available



- Ref. 187450
- External size 29,5 x 19 x 4,6 cm
- Internal size 28 x 18 x 2,8 cm



- Ref. 187460
- External size 19 x 14,5 x 4,6 cm
- Internal size 18 x 13,5 x 2,8 cm

Sterilizing containers

Anodised "high quality" aluminium - Colour 1 only. Multiperforated cover with lockable system. With replaceable filter system. Silicone heat resistant lockable seal (230°).

Paper filters available

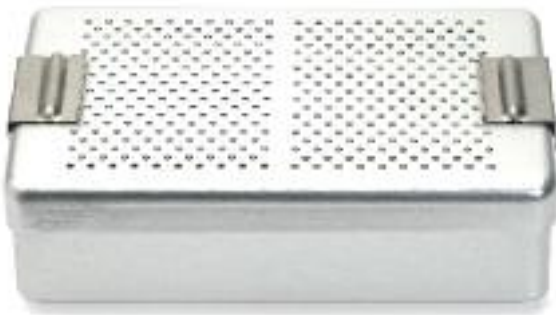

- Ref. 300200
- External size 26 x 16 x 8,5 cm
- Internal size 25 x 15 x 5,8 cm



- Ref. 300100
- External size 26 x 11 x 7,5 cm
- Internal size 25 x 10 x 5,1 cm



GERMICIDE BOX

- Ref. 182050
- Stainless steel - Size Ø 7,5 cm - H 3,5 cm
- Composed of 3 parts : 1 bowl, 1 perforated insert and 1 opening cover with slot. Suitable for burs and endodontic instruments decontamination.



COTTON HOLDERS / WASTE BINS

Cotton holder size : Ø 5,5 cm - H. 7,5 cm

Waste bin size : Ø 7 cm - H. 8 cm - Inside bowl

- Alu cotton Holder, colour 1 2Ref. 190300
- Alu waste bin, colour 1 2Ref. 190400
- Stainless steel cotton holderRef. 192300
- Stainless steel waste binRef. 192400

Sterilization Boxes :

Precise dimensions
on request

Aluminium products : refer
to instructions for use

ALUMINIUM BOXES

COLOUR 1



Standard sizes Reference

- 17 x 7 x 3 cm.....180014-1
- 18 x 9 x 3 cm.....180016-1
- 18 x 9 x 4 cm.....180017-1
- 21 x 10 x 3 cm.....180019-1
- 21 x 10 x 4 cm.....180020-1
- 21 x 10 x 5 cm.....180021-1



Particular sizes* Reference

- 10 x 3 x 2 cm.....180005-1
- 13 x 5 x 3 cm.....180007-1
- 25 x 10 x 5 cm180022-1
- 25 x 15 x 6 cm180024-1

**Available in
other colours
according to
quantities in
stock.*

COLOURED ALUMINIUM

BOXES 2 3 4 5



Colours 2

- | Size | Reference |
|-----------------------|-----------|
| • 17 x 7 x 3 cm..... | 180014-2 |
| • 18 x 9 x 3 cm..... | 180016-2 |
| • 21 x 10 x 3 cm..... | 180019-2 |
| • 21 x 10 x 5 cm..... | 180021-2 |

Colours 3

- | Size | Reference |
|-----------------------|-----------|
| • 17 x 7 x 3 cm..... | 180014-3 |
| • 18 x 9 x 3 cm..... | 180016-3 |
| • 21 x 10 x 3 cm..... | 180019-3 |
| • 21 x 10 x 5 cm..... | 180021-3 |

Colours 4

- | Size | Reference |
|-----------------------|-----------|
| • 17 x 7 x 3 cm..... | 180014-4 |
| • 18 x 9 x 3 cm..... | 180016-4 |
| • 21 x 10 x 3 cm..... | 180019-4 |
| • 21 x 10 x 5 cm..... | 180021-4 |

Colours 5

- | Size | Reference |
|-----------------------|-----------|
| • 17 x 7 x 3 cm..... | 180014-5 |
| • 18 x 9 x 3 cm..... | 180016-5 |
| • 21 x 10 x 3 cm..... | 180019-5 |
| • 21 x 10 x 5 cm..... | 180021-5 |

SMALL ALUMINIUM BOXES 5 X 4 X 2,5 cm



Colours 1

- Ref. 180004-1

Colours 2

- Ref. 180004-2

Colours 3

- Ref. 180004-3

Colours 4

- Ref. 180004-4

Colours 5

- Ref. 180004-5

Aluminium products : refer to instructions for use

ALUMINIUM PERFORATED BOXES

COLOUR 1

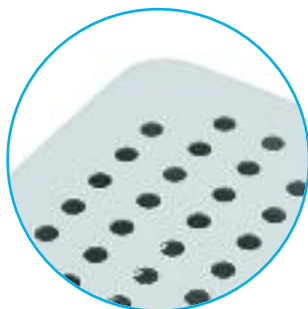

SPECIAL AUTOCLAVE

Size	Reference
• 17 x 7 x 3 cm.....	184014
• 18 x 9 x 3 cm.....	184016
• 21 x 10 x 3 cm.....	184019
• 21 x 10 x 5 cm.....	184021

STAINLESS STEEL BOXES



Size	Reference
• 17 x 7 x 3 cm.....	182014
• 18 x 9 x 3 cm.....	182016
• 21 x 10 x 3 cm.....	182019
• 21 x 10 x 5 cm.....	182021

ALUMINIUM PERFORATED BOXES



SPECIAL AUTOCLAVE

Size	Reference
• 17 x 7 x 3 cm.....	185014
• 18 x 9 x 3 cm.....	185016
• 21 x 10 x 3 cm.....	185019
• 21 x 10 x 5 cm.....	185021

POLYBOX



Size 18x9x3 cm

Made of polycarbonate. Very light and resistant material. Virtually unbreakable. Will support any type of sterilization up to 134°. Transparent cover allows direct view of the instruments.

- Blue colour.....Ref. 410016-2
- Green colour.....Ref. 410016-4
- Ivory colour.....Ref. 410016-1

POLYBOX PERFORATED



Size 18x9x3 cm

Made of polycarbonate. Very light and resistant material. Virtually unbreakable. Will support any type of sterilization up to 134°. Transparent cover allows direct view of the instruments.

- Blue colour.....Ref. 412016-2
- Green colour.....Ref. 412016-4
- Ivory colour.....Ref. 412016-1

Silicone Refills

SILICONE PLUGS FOR BURS STANDS

Set of 8 • Ref. 190200

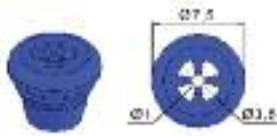

Set of 8. Colours 2 3 4 5 For Plug In (p.2-3-4), Ultralight Bur Holders (p.7) Endo Star (Burs area) (p.9) and some Implantology kits (p.17-19)

SILICONE PLUGS FOR ENDODONTIC STANDS

Set of 8 • Ref. 182175

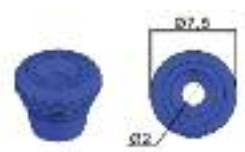

Set of 8. Colour 2 only. For Endo Star and Ultralight Endodontic Holder (p.9)

SILICONE TUBES - Set of 6

Colours 2 3 4 5

Centre slot available in 3 different sizes :

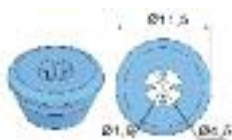

• Ref. 500600 - Set of 6 tubes
For instruments Ø 2 à 3,5 mm

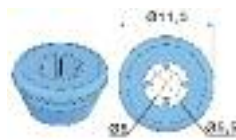

• Ref. 500610 - Set of 6 tubes
For instruments Ø 3,5 à 5 mm

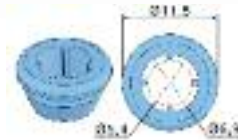

• Ref. 500620 - Set of 6 tubes
For instruments Ø 5 à 6,5 mm

For Implantology Kits (p.17-19), Multi Plug In, Multi Holder Clips, Multi Holders (p.4)



SILICONE CURSORS FOR STERIMETER - Set of 12

• Ref. 182370



Colours 2 3 4 5. For all endodontic stands (except aluminium range) (p.8-11)

SILICONE INDICATOR STRIPS - Set of 12

• Ref. 190275

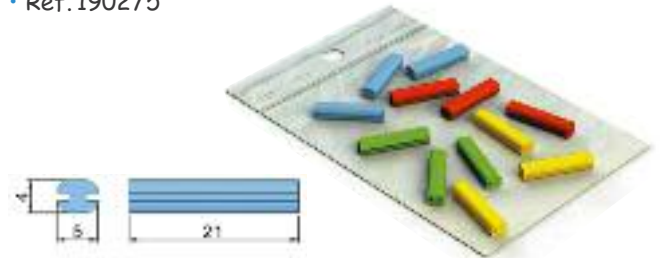

Colours 2 3 4 5. For Multi Plugs and Bur Clip Colour (p.4) Bur Flash (p.6), Micro Cassettes and Divided Cassettes (p.20)

SILICONE REFILLS FOR ERGO CLIPS (page 16)

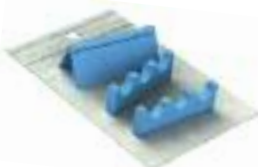

• Ref. 182713
For Ergo Clip 3
(Ref. 182703)



• Ref. 182705
For Ergo Clip 5
(Ref. 182700)

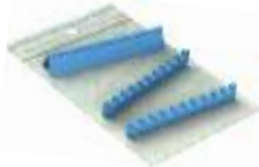

• Ref. 182715
For Ergo Clip 10
(Ref. 182710)



• Ref. 182722
For Ergo Clip 15
(Ref. 182712)



• Ref. 182736
For Ergo Clip 20
(Ref. 182720)



• Ref. 182721
For Ergo Clip 20MX
(Ref. 182725)

Silicone Refills

Silicone Refills
available in
colours **2 3 4 5**

SILICONE REFILLS FOR ROTATING KNOBS CASSETTES (page 12) AND ULTRALIGHT CASSETTES (page 13)

For Cassette 18x7
(Ref. 182069-182079-182039)



. Ref. 182078 4 instruments
. Ref. 182052 5 instruments
. Ref. 182088 2 handpieces

For Cassette 18x10
(Ref. 182054)



. Ref. 182084 6 instruments

For Cassette 18x14
(Ref. 182066-182056-182036)

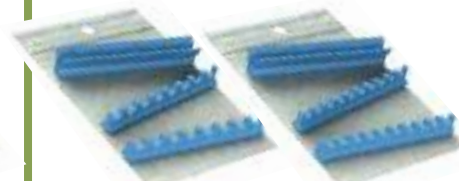

. Ref. 182077 8 instruments
. Ref. 182083 10 instruments

For Cassette 18x20
(Ref. 182057)



. Ref. 182082
MX : 8 instruments
+ Clear area

For Cassette 28x18
(Ref. 182068-182058-182087)



. Ref. 182071 16 instruments
. Ref. 182081 20 instruments
. Ref. 182074 MX : 10 instruments
+ Clear area

For Ultralight Cassette
28x18 (Ref. 182037)



. Ref. 182059
MX : 12 instruments
+ Clear area

SILICONE REFILLS FOR FLAT CASSETTES (page 12)



. Ref. 182073
For Cassette 18x6
(Ref. 182063)



. Ref. 182089
For Cassette 18x9
(Ref. 182055)



. Ref. 182072
For Cassette 18x13
(Ref. 182062)

SILICONE REFILLS FOR EASY CLIP (page 14)



. Ref. 182953
For Easy Clip 3
(Ref. 182903)



. Ref. 182955
For Easy Clip 5
(Ref. 182900)



. Ref. 182960
For Easy Clip 10
(Ref. 182910)



. Ref. 182965
For Easy Clip 15
(Ref. 182912)



. Ref. 182970
PF For Easy Clip 20
(Ref. 182920)

SILICONE REFILLS FOR EASY TRAYS (page 15)



. Ref. 182954
For Easy Tray 18x5
4 instrum. . Ref. 183704
. Ref. 182953 :
For Easy Tray 18x5
3 instrum. . Ref. 183703



. Ref. 183701
For Easy Tray 18x7
(Ref. 183700)



. Ref. 183706
For Easy Tray 18x10
(Ref. 183705)



. Ref. 183711
For Easy Tray 18x14
(Ref. 183710)

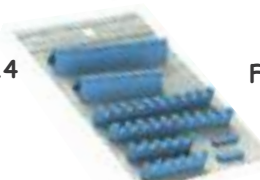

. Ref. 183716
For Easy Tray 21x18
(Ref. 183715)



. Ref. 183721
For Easy Tray 28x18
(Ref. 183720)

Valid from 01.10.2015 to 30.09.2016



NICHROMINOX



Made In France



Dealer :

18, rue des Frères Lumière - F-69720 SAINT-BONNET-DE-MURE - Tél. : 04 78 74 04 15 - Fax : 04 78 01 61 80
E-Mail : office@nichrominox.fr - Site : www.nichrominox.fr